

HIMC Installation Guide

Revision History

The version of the guide is also indicated on the bottom of the front cover.

MH07UE01-2303_V2.0

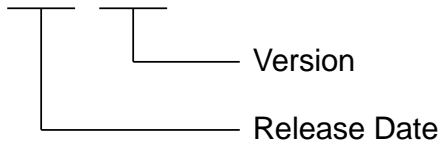

Release Date	Version	Applicable Product	Revision Contents
Mar. 15 th , 2023	2.0	HIMC	Section 2.1 “HIMC specifications”, Section 3.1 “Overview”. Modify CoE communication relative specifications.
Jun. 30 th , 2022	1.7	HIMC	Section 2.1 “HIMC specifications”, Section 3.3 “CN6 digital I/O”: General purpose input should be PNP type.
Sep. 18 th , 2020	1.6	HIMC	<ol style="list-style-type: none"> Section 2.2 “Dimensions”: Modify Figure 2.2.1. Section 2.3 “Installation”: Modify Figure 2.3.1.
Jul. 22 nd , 2020	1.5	HIMC	Section 2.1 “HIMC specifications”: Modify the description of programming and add the description of Host communication interface.
Nov. 29 th , 2019	1.4	HIMC	Modify the description of CN3 and CN4 in Table 3.1.1.
Mar. 22 nd , 2019	1.3	HIMC	<ol style="list-style-type: none"> Modify names of digital I/O. Modify chapter’s arrangement.
Dec. 5 th , 2017	1.2	HIMC	Fix typo in section “LED Indicator”.
Oct. 16 th , 2017	1.1	HIMC	Fix section number in Chapter 3.
Sep. 1 st , 2017	1.0	HIMC	<ol style="list-style-type: none"> Reformat section “Safety Instructions Before Use.” Add wiring conductor limit temperature.
Aug. 24 th , 2017	0.9	HIMC	<ol style="list-style-type: none"> Modify input power rating. Modify CN1 wiring requirement. Remove sourcing input option (NPN). Modify built-in I/O current limit and wiring diagrams. Modify storage temperature.
Aug. 22 nd , 2017	0.8	HIMC	Change model name.

Release Date	Version	Applicable Product	Revision Contents
Aug. 21 st , 2017	0.7	HIMC	<ol style="list-style-type: none"> 1. Add description for connector installation. 2. Add description for mounting orientations.
Aug. 16 th , 2017	0.6	HIMC	Reformat contents.
Aug. 8 th , 2017	0.5	HIMC	<ol style="list-style-type: none"> 1. Modify chapter's arrangement. 2. Modify description of LED indicator. 3. Modify the maximum number of axes in specifications.
May 17 th , 2017	0.4	HIMC	Modify Ethernet port speed.
May 12 th , 2017	0.3	HIMC	<ol style="list-style-type: none"> 1. Add Chapter 1 "Introduction". 2. Add Chapter 4 "Troubleshooting".
May 5 th , 2017	0.2	HIMC	<ol style="list-style-type: none"> 1. Add figures in all sections. 2. Add Chapter 3 "Connectors and Wiring".
Apr. 24 th , 2017	0.1	HIMC	First edition.

Related Documents

The figure and table of the documents related to the product are shown below. Refer to these documents as required.

Product

- Controller**
 - HIMC Motion Controller
- Servo Drive**
 - E Series Servo Drive
 - D Series Servo Drive
- Motor**
 - Linear Motor
 - Direct Drive Motor
 - Torque Motor
 - AC Servo Motor
 - IM-1 Series Spindle Motor
- Linear Motor Stage**
 - Standard Single-Axis Linear Motor Stage
- Actuator**
 - Linear Actuator

Product		Doc. Name	Doc. No.	Content
Controller	HIMC Motion Controller	HIMC Installation Guide	MH07UE01-□□□□	Provides detailed information on installing and connecting HIMC motion controller.
		HIMC iA Studio User Guide	MH01UE01-□□□□	Provides detailed information on the human machine interface operation of HIMC motion controller.
		HIMC Modbus TCP User Guide	MH02UE01-□□□□	Provides detailed information on the way Modbus TCP communication protocol applied to HIMC motion controller.
		HIMC HMPL User Guide	MH06UE01-□□□□	Provides detailed information on HMPL library of HIMC motion controller.
		HIMC API Reference Guide	MH05UE01-□□□□	Provides detailed information on API library of HIMC motion controller.
		HIOM Installation Guide	MH03UE01-□□□□	Provides detailed information on installing and connecting HIOM (HIWIN mega-ulink IO module).
		ETA3 Installation Guide	MH09UE01-□□□□	Provides detailed information on installing and connecting ETA3 (HIMC remote module).
Servo Drive	E Series Servo Drive	E1 Series Servo Drive User Manual	MD09UE01-□□□□	Provides detailed information on selecting, installing, connecting, setting, performing test run for, tuning, and monitoring E1 series servo drive.
		E2 Series Servo Drive User Manual	MD28UE01-□□□□	Provides detailed information on selecting, installing, connecting, setting, performing test run for, tuning, and monitoring E2 series servo drive.
		E1 Series Servo Drive Thunder Software Operation Manual	MD12UE01-□□□□	Provides detailed information on the human machine interface operation of E1 series servo drive.
		E1 Series Servo Drive EtherCAT(CoE) Communications Command Manual	MD08UE01-□□□□	Provides detailed information on the way EtherCAT communication protocol applied to E1 series servo drive.
		E1 Series Servo Drive MECHATROLINK-III Communication Command Manual	MD24UE01-□□□□	Provides detailed information on the way MECHATROLINK-III communication protocol applied to E1 series servo drive.
		E1 Series Servo Drive PROFINET Communication Command Manual	MD02UE01-□□□□	Provides detailed information on the way PROFINET communication protocol applied to E1 series servo drive.
		E1 Series Servo Drive Gantry Control System User Manual	MD22UE01-□□□□	Provides detailed information on the usage of E1 series servo drive gantry control system.
		E1 Series Servo Drive Electronic Cam Control System User Manual	MD27UE01-□□□□	Provides detailed information on the usage of E1 series servo drive electronic cam control system.
		E1 Series Servo Drive Multi-Motion Function User Manual	MD32UE01-□□□□	Provides detailed information on the usage of E1 series servo drive multi-motion function.
		MPI Library Reference Manual	MD19UE01-□□□□	Provides detailed information on MPI library of E1 series servo drive and D series servo drive.
		MPI Examples	MD18UE01-□□□□	Provides detailed information on MPI examples of E1 series servo drive and D series servo drive.
		API Library Reference Manual for Servo Drives	MD23UE01-□□□□	Provides detailed information on API library of E1 series servo drive and D series servo drive.
		PDL Examples for E1 Series Servo Drive	MD25UE01-□□□□	Provides detailed information on PDL examples of E1 series servo drive.

Product		Doc. Name	Doc. No.	Content
Servo Drive	E Series Servo Drive	Application Note E1 PROFINET Drive Complete Setup with Siemens TIA Portal	MD30UE01-□□□□	Provides detailed information on the operation of PLC software TIA Portal when E1 PROFINET drive is used with Siemens S7 series PLC.
		Application Note E1 MECHATROLINK-III Drive Complete Setup with YASKAWA MPE720	MD31UE01-□□□□	Provides detailed information on the operation of machine controller software MPE720 when E1 MECHATROLINK-III drive is used with YASKAWA MP3000 series machine controller.
Servo Drive	D Series Servo Drive	D1 Servo Drive User Manual	MD20UE01-□□□□	Provides detailed information on selecting, installing, connecting, setting, performing test run for, tuning, and monitoring D1 servo drive.
		D2 Series Servo Drive User Manual	MD07UE01-□□□□	Provides detailed information on selecting, installing, connecting, setting, performing test run for, tuning, and monitoring D2T servo drive.
		D2T-LM Series Servo Drive User Manual	MD11UE01-□□□□	Provides detailed information on selecting, installing, connecting, setting, performing test run for, tuning, and monitoring D2T-LM servo drive.
		MPI Library Reference Manual	MD19UE01-□□□□	Provides detailed information on MPI library of E1 series servo drive and D series servo drive.
		MPI Examples	MD18UE01-□□□□	Provides detailed information on MPI examples of E1 series servo drive and D series servo drive.
		API Library Reference Manual for Servo Drives	MD23UE01-□□□□	Provides detailed information on API library of E1 series servo drive and D series servo drive.
		PDL Examples for D-series Drives User Manual	MD13UE01-□□□□	Provides detailed information on PDL examples of D series servo drive.
Motor	Linear Motor	Linear Motor User Manual	MP99UE01-□□□□	Provides detailed information on selecting, installing, and connecting linear motor.
	Direct Drive Motor	DMN Series Direct Drive Motor User Manual	MR01UE01-□□□□	Provides detailed information on selecting, installing, and connecting DMN series direct drive motor.
		DMT Series Direct Drive Motor User Manual	MR03UE01-□□□□	Provides detailed information on selecting, installing, and connecting DMT series direct drive motor.
		DMY Series Direct Drive Motor User Manual	MR04UE01-□□□□	Provides detailed information on selecting, installing, and connecting DMY series direct drive motor.
		DMS Series Direct Drive Motor User Manual	MR05UE01-□□□□	Provides detailed information on selecting, installing, and connecting DMS series direct drive motor.
		DMR Series Direct Drive Motor User Manual	MR06UE01-□□□□	Provides detailed information on selecting, installing, and connecting DMR series direct drive motor.
	Torque Motor	Torque Motor User Manual	MW99UE01-□□□□	Provides detailed information on selecting, installing, and connecting torque motor.
	AC Servo Motor	AC Servo Motor User Manual	MC03UE01-□□□□	Provides detailed information on selecting, installing, and connecting AC servo motor.
IM-1 Series Spindle Motor	IM-1 Series Spindle Motor User Manual	MS01UE01-□□□□	Provides detailed information on selecting and installing IM-1 series spindle motor.	
Linear Motor	Standard Single-Axis Linear Motor	Standard Single-Axis Linear Motor Stage User Manual	MM06UE01-□□□□	Provides detailed information on selecting, installing, and connecting

Product		Doc. Name	Doc. No.	Content
Stage	Stage			standard single-axis linear motor stage.
Actuator	Linear Actuator	Linear Actuator User Manual	MA99UE01-□□□□	Provides detailed information on selecting, installing, and connecting linear actuator.

Table of Contents

1.	About this guide	1-1
1.1	General precautions	1-2
1.2	Safety precautions	1-3
1.3	Package list	1-6
2.	Specifications	2-1
2.1	HIMC specifications	2-2
2.2	Dimensions	2-4
2.3	Installation	2-5
2.4	LED indicator	2-6
3.	Wiring	3-1
3.1	Overview	3-2
3.2	CN1 power input	3-3
3.3	CN6 digital I/O	3-4

1. About this guide

1.	About this guide	1-1
1.1	General precautions	1-2
1.2	Safety precautions	1-3
1.3	Package list	1-6





1.1 General precautions

This guide is for HIMC, HIWIN Motion Controller. Before using the product, please carefully read through this guide. HIWIN Mikrosystem (HIWIN) is not responsible for any damage, accident or injury caused by failure in following the installation instructions and operating instructions stated in this guide.

- Do not disassemble or modify the product. The design of the product has been verified by structural calculation, computer simulation and actual testing. HIWIN is not responsible for any damage, accident or injury caused by disassembly or modification done by users.
- Before installing or using the product, ensure there is no damage on its appearance. If any damage is found after inspection, please contact HIWIN or local distributors.
- Carefully read through the specification noted on product label or technical document. Install the product according to its specification and installation instructions stated in this guide.
- Ensure the product is used with power supply specified on product label or in product requirement. HIWIN is not responsible for any damage, accident or injury caused by incorrect power supply.
- Do not repair the product by yourself when it malfunctions. The product can only be repaired by qualified technician from HIWIN.



1.2 Safety precautions

- Carefully read through this guide before installation, transportation, maintenance and examination. Ensure the product is correctly used.
- Carefully read through electromagnetic (EM) information, safety information and related precautions before usage.
- Safety precautions in this guide are classified into “Warning”, “Attention”, “Prohibited” and “Required”.

Signal Word	Description
 Warning	It indicates if the precaution is not observed, it is likely to cause property loss, severe injury or death.
 Attention	It indicates the precaution must be observed.
 Prohibited	It indicates prohibited activity.
 Required	It indicates mandatory activity.

If the product is not used in the manner specified in this guide, the protection provided by the product may be impaired.

■ Operation

 <p>Warning</p>	<ul style="list-style-type: none">◆ Do not touch the terminals and the internal part of the product when power on, or it may cause electric shock.◆ Do not touch the terminals and internal part of the product within 10 minutes after power off, or the residual voltage may cause electric shock.◆ Do not modify wiring when power on, or it may cause electric shock.◆ Do not damage, apply excessive force to place any heavy object on the cable or put the cable between two objects, or it may cause electric shock or fire.
 <p>Attention</p>	<ul style="list-style-type: none">◆ Do not use the product in location which is subject to humidity, corrosive materials, flammable gas or flammable materials.

■ Storage

 <p>Prohibited</p>	<ul style="list-style-type: none">◆ Do not store the product in location which is subject to water, water drop, direct sunlight, harmful gas or liquid.
--	---

■ Transportation

 <p>Attention</p>	<ul style="list-style-type: none">◆ Carefully move the product to avoid damage.◆ Do not apply excessive force to the product.◆ Do not stack the products to avoid collapse.
---	---

■ Installation site

 <p>Required</p>	<ul style="list-style-type: none">◆ Do not install the product in location with high ambient temperature and high humidity or location which is subject to dust, iron powder or cutting powder.◆ Install the product in location with ambient temperature stated in the guide. Use cooling fan if the ambient temperature is too high.◆ Do not install the product in location which is subject to direct sunlight.◆ The product is not drip-proof or waterproof, so do not install or operate the product outdoor or in location which is subject to water or liquid.◆ Install the product in location with less vibration.
--	--

■ Installation

 Attention	<ul style="list-style-type: none">◆ Do not place heavy object on the product, or it may cause injury.◆ Prevent any foreign matter from entering the product, or it may cause fire.◆ Install the product in the specified orientation, or it may cause fire.◆ Avoid strong shock to the product, or it may cause malfunction or injury.◆ When installing the product, take the product weight into consideration. Improper installation may cause damage.◆ Install the product on noncombustible objects, such as metal to avoid fire.
--	--



■ Wiring

 Attention	<ul style="list-style-type: none">◆ Ensure wiring is correctly performed, or it may cause malfunction or burn. There is a risk of injury or fire.
--	---

■ Operation and transportation





 Attention	<ul style="list-style-type: none">◆ Use power supply specified in product specification, or it may cause injury or fire.◆ The product may suddenly start to operate after power supply recovers. Please do not get too close to the product.
--	---

■ Maintenance

 Prohibited	<ul style="list-style-type: none">◆ Do not disassemble or modify the product.◆ Do not repair the product by yourself when it malfunctions, please contact HIWIN for help.
 Required	<ul style="list-style-type: none">◆ The product is for indoor use. It can only be kept in the environment that the degree of contamination is 2. Clean up the appearance with a dry cloth.

1.3 Package list

The product package comes with the following items. If any of them is missing or damaged, please contact Customer Service Department for assistance.

-  1 x HIWIN Motion Controller, HIMC
-  1 x DIN Mount Kit
-  1 x Phoenix Contact 20 pin
-  1 x Phoenix Contact 4 pin

2. Specifications

2.	Specifications	2-1
2.1	HMC specifications	2-2
2.2	Dimensions	2-4
2.3	Installation	2-5
2.4	LED indicator.....	2-6

2.1 HIMC specifications

Motion control	
Maximum motion axes	16
Maximum slaves	32 (including motor drives and I/O devices)
Motion types	Single axis motion: point-to-point, jog Group interpolation: multi-axis linear interpolation
Motion profile	Trapezoidal profile with smooth time from 0 to 500 msec
Dynamic error compensation	Geometric compensation for increasing positioning accuracy
Position precision	32-bit resolution
Numerical precision	Double floating-point precision real-time trajectory generation

Programming	
Motion script	HMPL (HIWIN Motion Programming Language) High-level multi-tasking environment Up to 64 simultaneously running user tasks
User-defined variable table	Up to 512,000 double precision user defined variables
User program size	Up to 10MB of source code
HIMC API software library	library for C / C++, C#, Python and LabVIEW

Communication	
Communication port	10/100/1000 Base-T Ethernet with TCP/IP x2
Host communication protocol	API, Modbus and ASCII TCP
Number of Host communication	Communication protocols mentioned above can support up to 9 clients at the same time. Each communication protocol can simultaneously connect to 3 clients, but users need to pay attention to the access privilege issue (refer to section 2.1.4 in "iA Studio User Guide" for details).

CANopen over EtherCAT	
Cycle time	250µs/500µs/1ms/2ms/4ms
Supported modules	CANopen over EtherCAT compatible motor drives and I/O devices

Computational capability	
Processor	Intel® Celeron® Bay Trail J1900 (Quad-core)
Memory	On board 2GB DDR3L 1333 MHz SDRAM
Storage	mSATA SSD 32G

Built-in I/O	
General purpose input	8x Opto-isolated 24V, delay time within 1ms. (PNP)
General purpose output	8x Opto-isolated 24V, delay time within 1ms.(NPN)
GPIO current limit	Max. 100mA. Total 0.8A per bank of 8.

Power	
Main power input	DC 24V / 0.6A
Power consumption	Max. 14.4W
Status LED	Refer to Section 2.4

Mechanical characteristics	
Size (WxHxD)	57 x 180 x 140 mm.
Weight	approx.1200g
Mounting	DIN in an enclosure or industrial panel
Chassis construction	Extruded aluminum alloy for fan-less support

Environment	
Protection class	IP30
Operating temperature	0°C~50°C
Storage temperature	-20°C~85°C
Operating altitude	Up to 2000m
Ventilation	fan-less convection cooling
Humidity	5%~95%, non-condensing
Vibration	Random: 5~500Hz, 2G Sine: 10~500Hz, 5G
Shock	5G duration: 11ms

Certificates	
EMC	EN61000-6-2, EN61000-6-4
Safety	UL61010-1, UL61010-2-201, EN61010-1, EN61010-2-201, ISO 14971

2.2 Dimensions

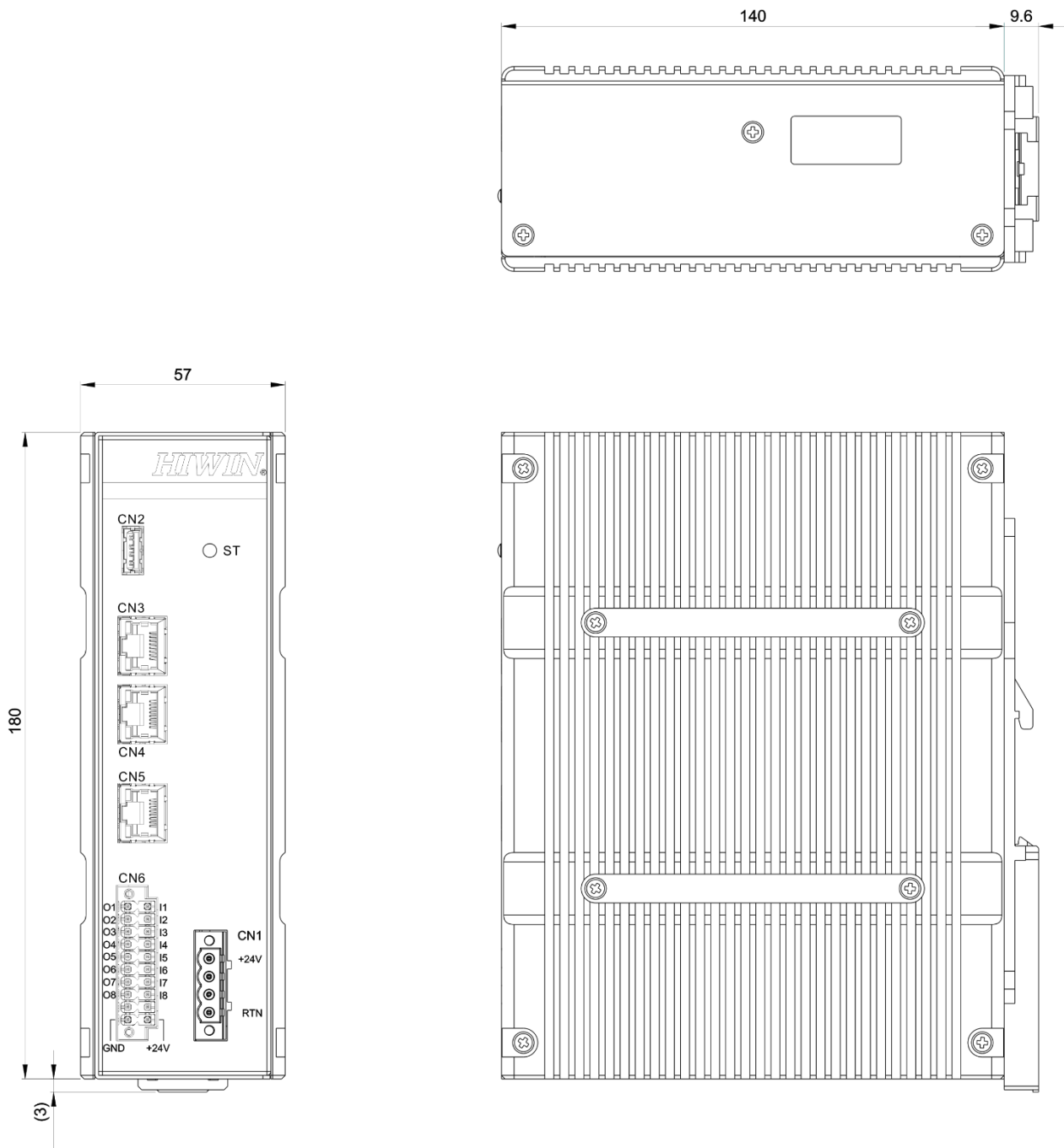

Figure 2.2.1 Dimensions (unit: mm)

2.3 Installation

REQUIRED

- ◆ Based on UL61010-2-201, HIMC should be mounted on the industrial control panel and the maximum ambient temperature is 50°C.

- Step 1. Align the mounting holes of the bracket in the system and those on the DIN rail bracket.
- Step 2. Use the provided mounting screws to secure the bracket in place.
- Step 3. Mount the product on the industrial control panel with the recommended orientation, as Figure 2.3.2 shows.

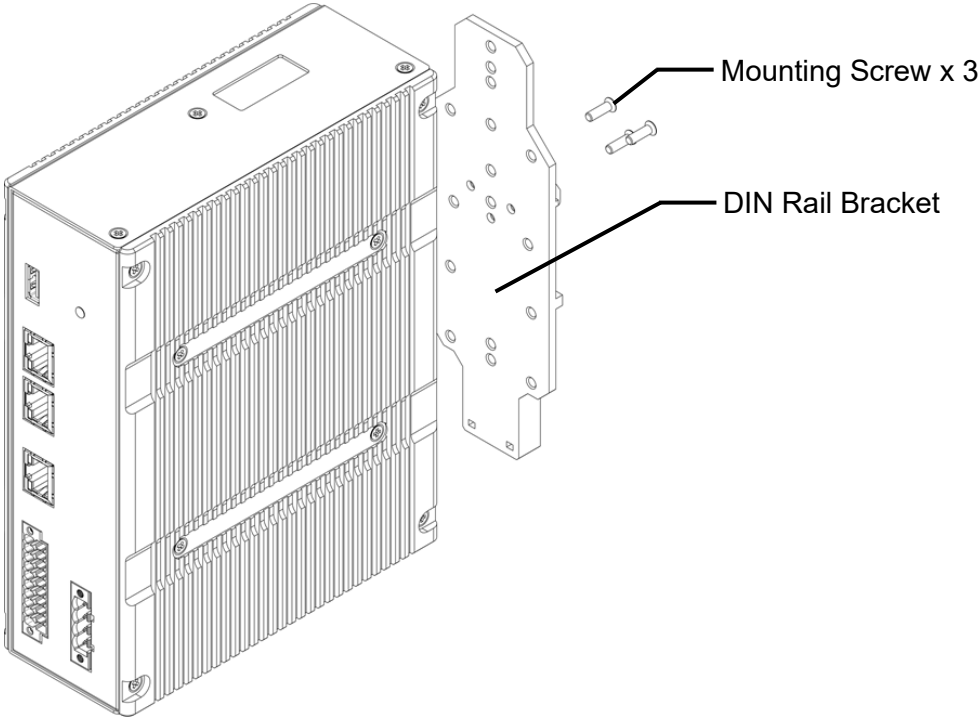

Figure 2.3.1 DIN rail bracket

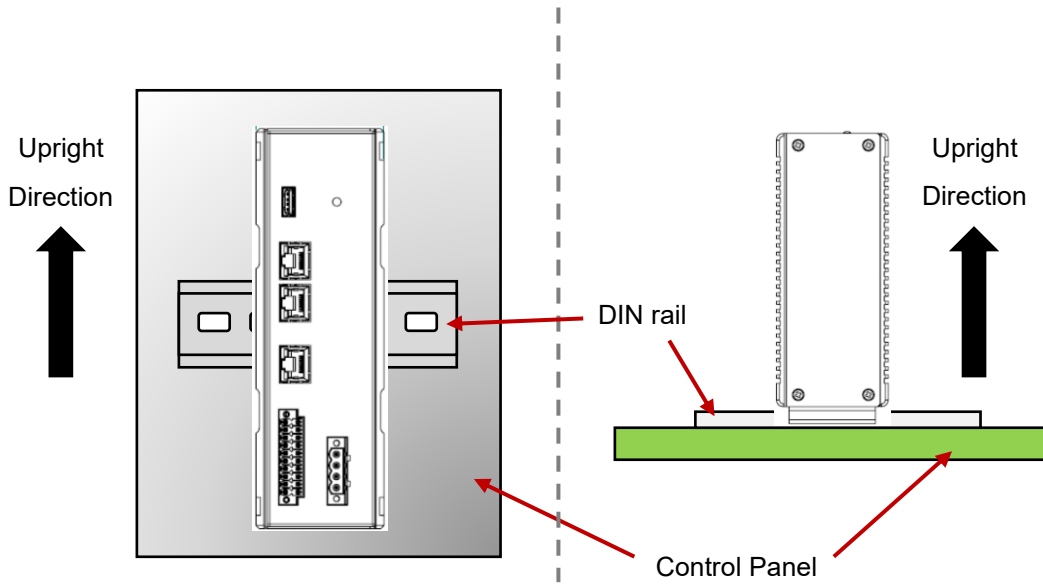

Figure 2.3.2 Recommended mounting orientation

2.4 LED indicator

Table 2.4.1 LED indicator

Color	Status	Description
No light		Power off
White	Solid	Boot
	Blinking	Initializing
Green	Solid	Operation
	Blinking	Pre-operation
Red	Solid	Hardware binding failed
	Blinking	Error

3. Wiring

3.	Wiring	3-1
3.1	Overview	3-2
3.2	CN1 power input	3-3
3.3	CN6 digital I/O	3-4

3.1 Overview

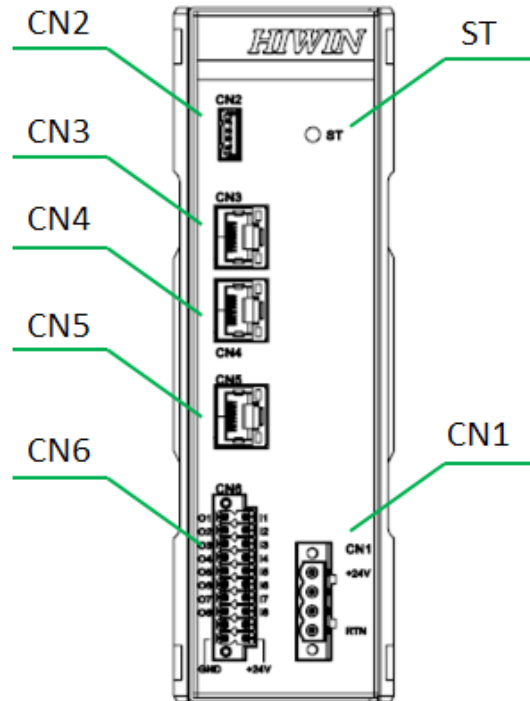

Figure 3.1.1 HIMC front panel

Table 3.1.1 Wiring overview

Item	Connector	Description
CN1	Phoenix 4 pin	Power Input 24V
CN2	USB connector	Update controller firmware
CN3	RJ45	Communication with customers' PC or devices (Default IP address: 0.0.0.0)
CN4	RJ45	Communication with customers' PC or devices (Fixed IP address: 169.254.188.20)
CN5	RJ45	Communication with CANopen over EtherCAT (CoE) slaves
CN6	Phoenix 20 pin	Digital inputs/outputs
ST	N/A	Controller status

3.2 CN1 power input

REQUIRED

- ◆ Use SELV or double insulated qualified power supply based on UL60950, UL61010-1 or UL61010-2-201 standard.
- ◆ The power input connector (CN1) is suitable for AWG (American Wire Gauge) 18~22 (0.326~0.823 mm²). With the rated load current, conductor limit temperature should be less than 60°C for operation.
Screw torque: 0.5N-m

Note: Make sure that the voltage of the DC power source is stable before connecting HIMC to DC power input.

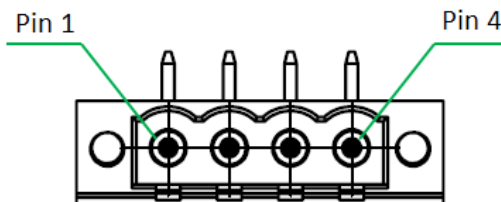

Figure 3.2.1 CN1 connector type

Table 3.2.1 CN1 pin assignment

Pin	Name	Description	Remarks
1	+24V	+24VDC supply	Power requirement: DC 24V/0.6A
2	N/C	Not connected	
3	N/C	Not connected	
4	RTN	+24VDC supply return	

3.3 CN6 digital I/O

REQUIRED	
◆	Use SELV or double insulated qualified power supply based on UL60950, UL61010-1 or UL61010-2-201 standard.
◆	The digital I/O connector (CN6) is suitable for AWG (American Wire Gauge) 18~24 (0.205~0.823 mm ²). With the rated load current, conductor limit temperature should be less than 60°C for operation. Screw torque: 0.5N-m

HIMC provides 8 general purpose inputs and 8 general purpose outputs. The input type should be PNP type.

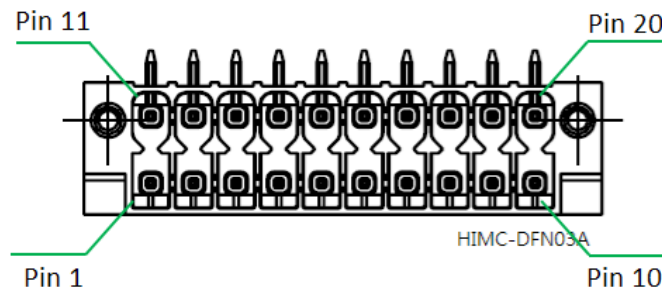

Figure 3.3.1 CN6 connector type

Table 3.3.1 CN6 pin assignment

Pin	Name	Description	Pin	Name	Description
1	I1	Digital input 1	11	O1	Digital output 1
2	I2	Digital input 2	12	O2	Digital output 2
3	I3	Digital input 3	13	O3	Digital output 3
4	I4	Digital input 4	14	O4	Digital output 4
5	I5	Digital input 5	15	O5	Digital output 5
6	I6	Digital input 6	16	O6	Digital output 6
7	I7	Digital input 7	17	O7	Digital output 7
8	I8	EMO	18	O8	Digital output 8
9	N/C	Not connected	19	OCOM	Output common point
10	VIN	+24VDC supply	20	GND	Digital Ground

Note: The last input (I8) is for Emergency Machine Off.

■ Input wiring (PNP)

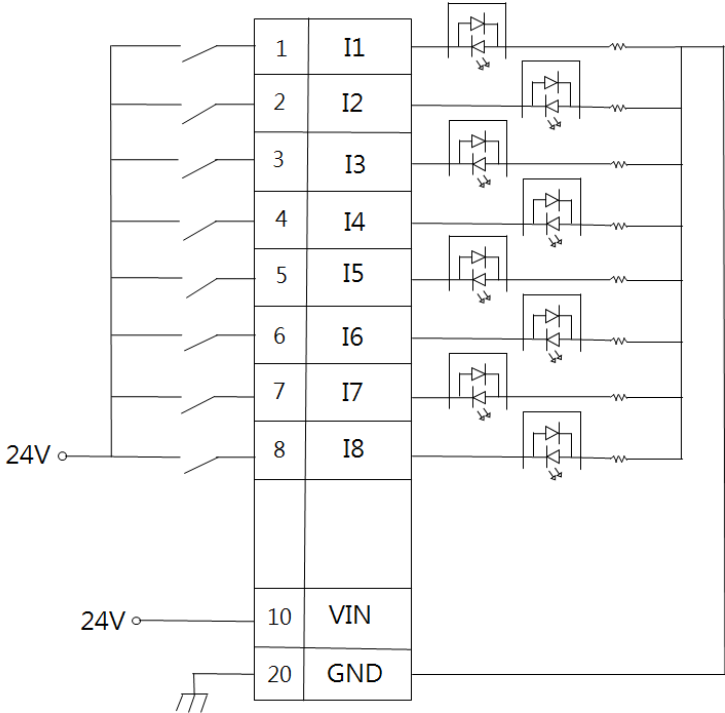

Figure 3.3.2

■ Output wiring (NPN)

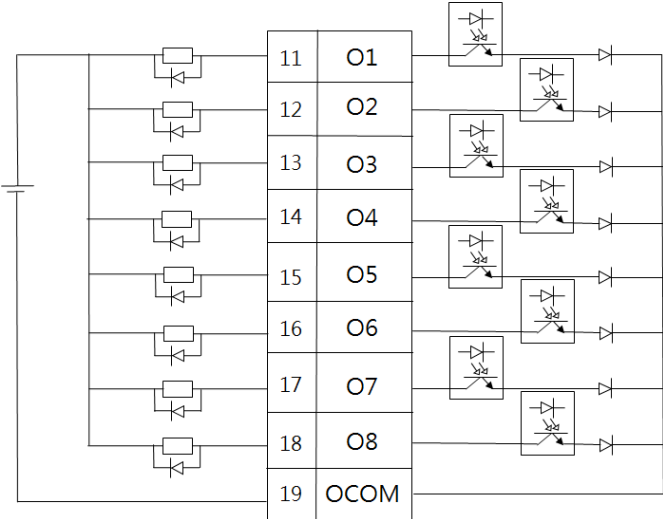

Figure 3.3.3

(This page is intentionally left blank.)